

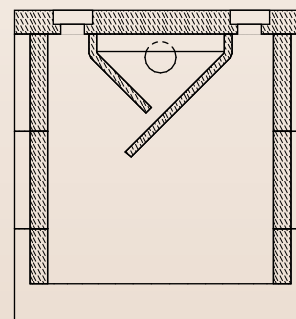

## FOSSA BIOLOGICA TIPO IMHOFF

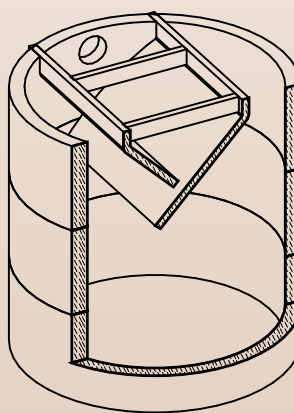
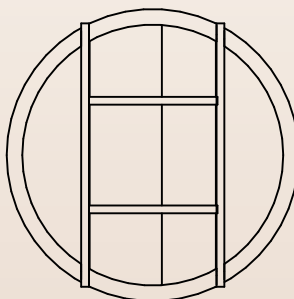
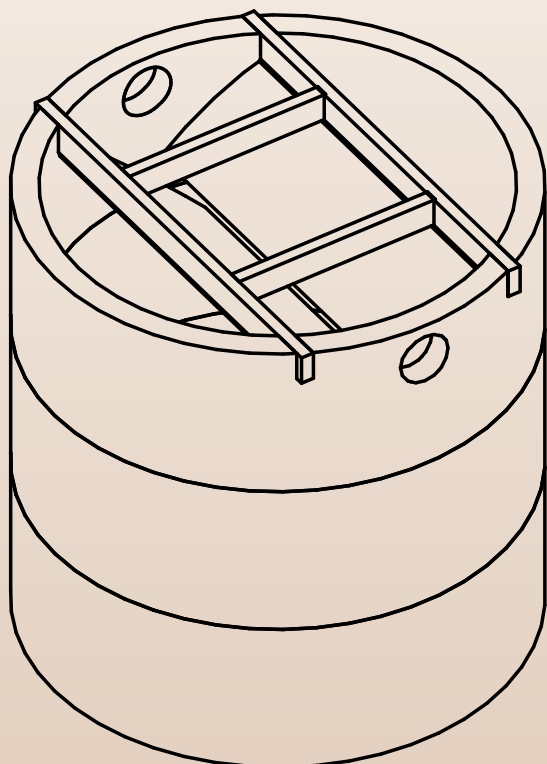

Fossa imhoff ø 100

ø cm	h cm	capacità litri	dotazione idrica	persone servite
100	150	942	180	5
100	200	1334	180	7
100	250	1727	180	9
100	300	2119	180	11

Fossa imhoff ø 150

ø cm	h cm	capacità litri	dotazione idrica	persone servite
150	150	2119	180	11
150	200	3000	180	16
150	250	3885	180	21
150	300	4765	180	26
150	350	5651	180	31

### Coperchio diam. 110x8

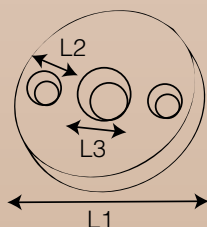

DIMENSIONE :  
L1 = cm 114  
L2 = cm 22  
L3 = cm 49  
H = cm 9

PESO PER PEZZO : Kg 190

### Coperchio diam. 160x12

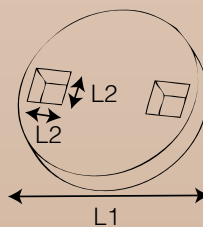

DIMENSIONE :  
L1 = cm 162  
L2 = cm 35,5  
H = cm 11,5

PESO PER PEZZO : Kg 545

### Coperchio carrabile diam. 160x20

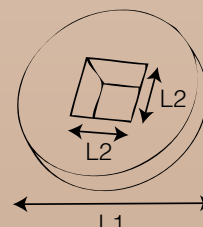

DIMENSIONE :  
L1 = cm 162  
L2 = cm 60  
H = cm 20

PESO PER PEZZO : Kg 905